

● F Notice de montage
 ● NL Montage-instructies
 ● D Montageanleitung

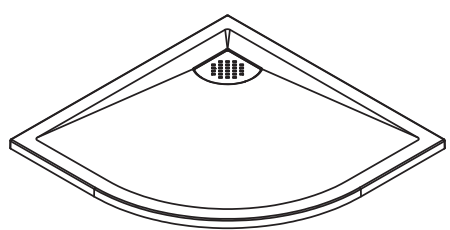
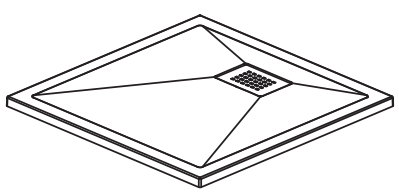
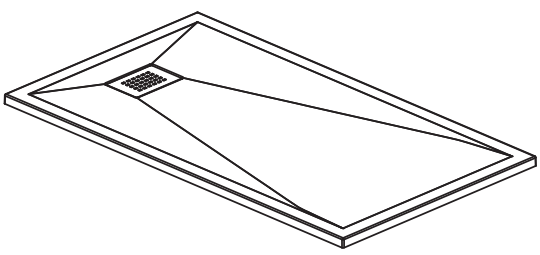
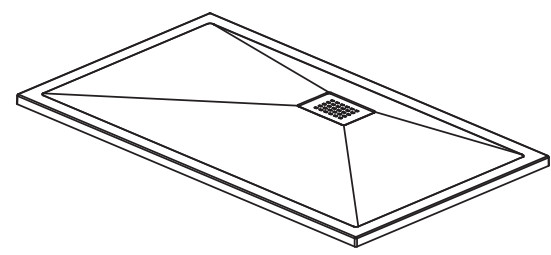

● F Attention aux étapes : Pages: 4 - 5 - 6
 ● NL Aandacht voor de stappen : Pagina's: 10 - 11 - 12
 ● D Achtung vor den Schritten : Seiten: 16 - 17 - 18

(A)

X1

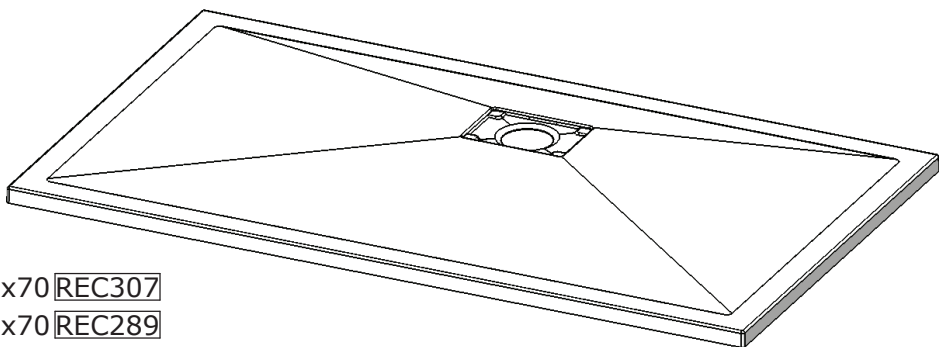

90x70	REC307				
100x70	REC289				
100x80	REC308	120x90	REC313	150x90	REC394
100x90	REC297	140x70	REC291	160x70	REC292
120x70	REC290	140x80	REC310	160x80	REC300
120x80	REC309	140x90	REC299	160x90	REC398
				170x70	REC301
				170x80	REC302
				170x90	REC298
				180x80	REC303

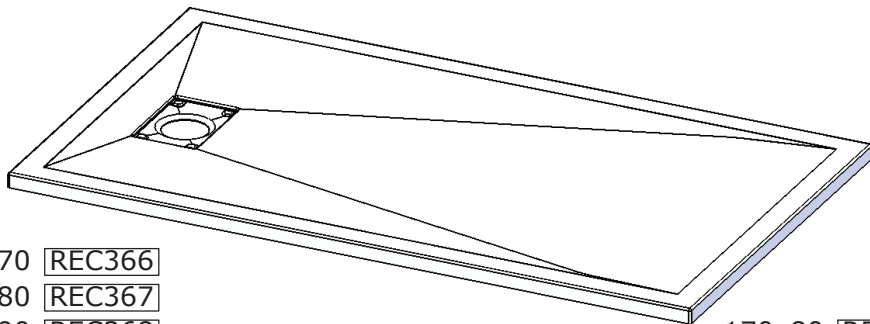

120x70	REC366				
120x80	REC367				
120x90	REC368				170x80
120x100	REC576	140x100	REC531	160x80	REC373
140x70	REC369	150x90	REC393	160x90	REC397
140x80	REC370	150x100	REC533	180x80	REC377
140x90	REC371	160x70	REC372	180x90	REC537
				170x70	REC374
				180x100	REC577

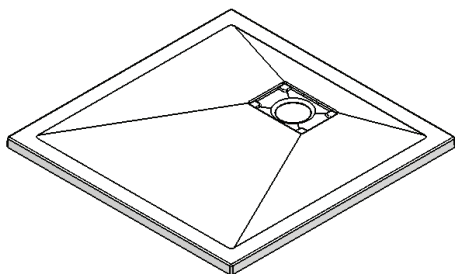

80x80	REC304
90x90	REC305
100x100	REC306

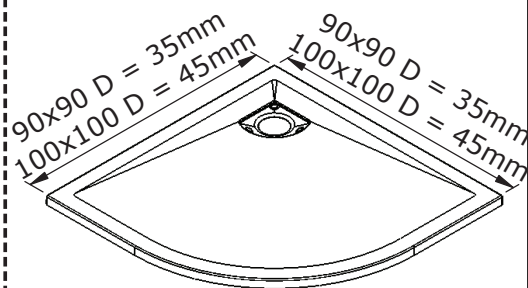

90x90	REC311
100x100	REC312

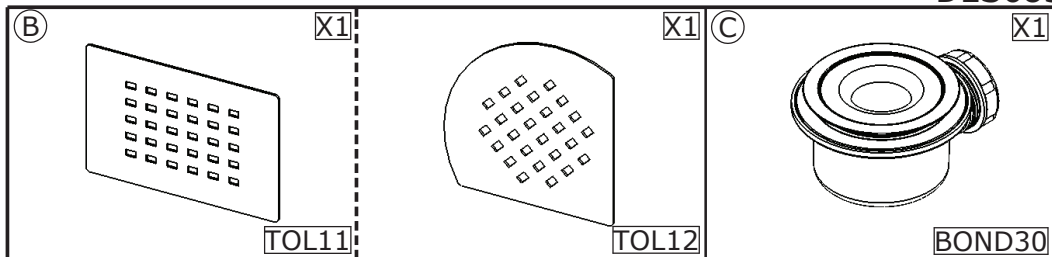

- Les quantités données sont les quantités utiles au montage. les sachets fournis contiennent des pièces supplémentaires.
 - De aangegeven aantallen zijn vereist voor de montage. De verpakking bevat extra onderdelen.
- Die Mengenangaben beziehen sich auf die für die Montage nötigen Teile. Eventuell weitere beige packte Teile ignorieren.

- | | |
|----|----------------------|
| F | Matériel nécessaire |
| NL | Benodigd gereedschap |
| D | Benötigtes Werkzeug |

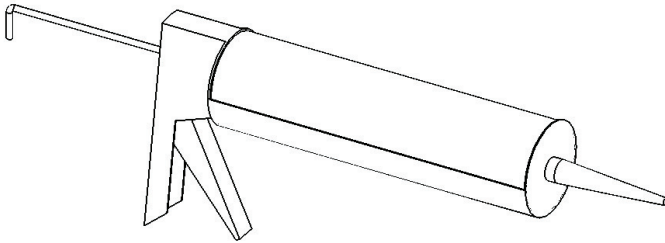

Utiliser un silicone adapté au matériau de chaque support (faïence, acrylique, etc.)

Gebruik siliconenkit die geschikt is voor iedere ondergrond (tegelwerk, acryl, etc.)

Für das jeweilige Trägermaterial (Stein, Acryl usw.) geeignetes Silikon verwenden

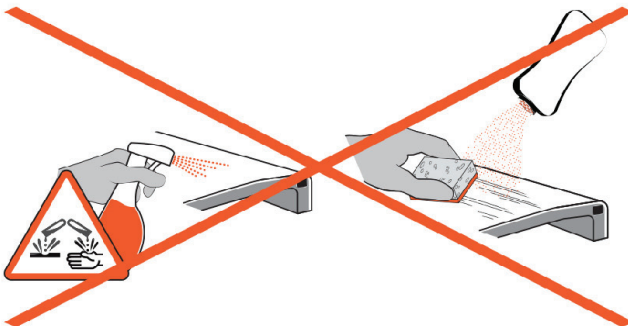
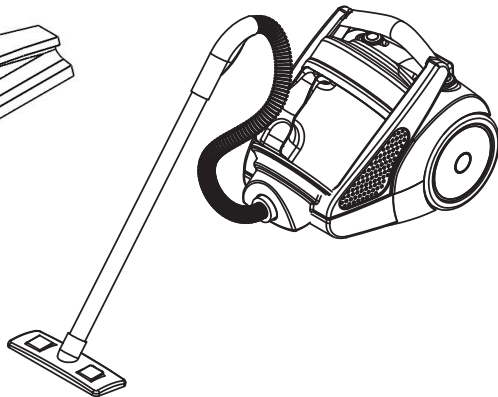
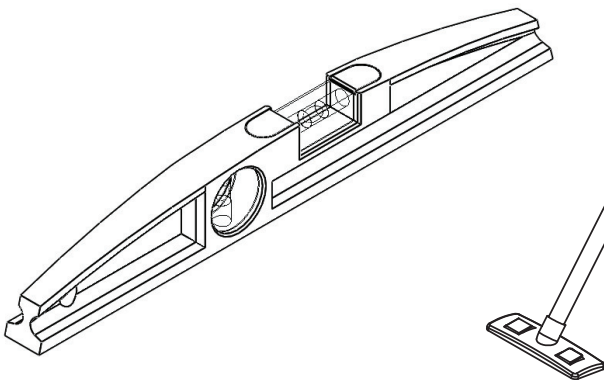

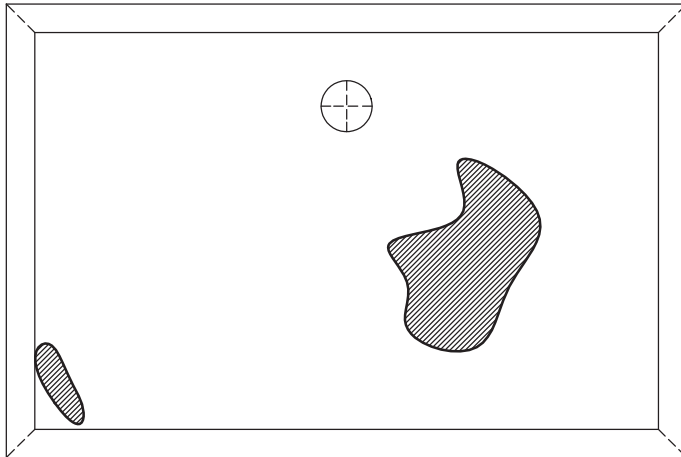

- F** D'éventuelles irrégularités de surface sur le dessous de votre receveur n'empêchent pas une installation conforme aux préconisations de pose. La colle (type MAP, polyuréthane ou MS polymère) comblera facilement ces manques lors du collage.
- NL** Eventuele onregelmatigheden in de vlakke onderzijde van uw douchebak vormen geen belemmering voor een installatie conform aan de gestelde richtlijnen. De lijm (type MAP, polyurethaan of MS-polymeer) vult eventuele openingen makkelijk op tijdens het lijmen.
- D** Eventuelle Unregelmäßigkeiten der Oberfläche an der Unterseite Ihrer Duschwanne haben keinen Einfluss auf die Installation gemäß den Einbauempfehlungen. Der Klebstoff (Typs MAP, Polyurethan oder MS-Polymer) gleicht diese Unebenheiten beim Verkleben problemlos aus.



- F** Aspirer le dessous de votre receveur avant la pose
- NL** Stofzuig de bodem van de douchebak voor de installatie
- D** Saugen Sie den Boden der Duschwanne vor der Installation ab

F

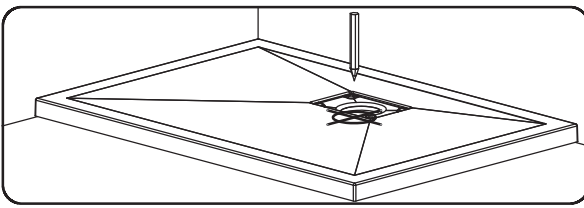

Tracer la position de la bonde et réaliser un montage à blanc de la bonde et du receveur



Le receveur ne doit subir aucune modification (sciage, meulage de renfort...) autre que celles prévues par le fabricant.

- ① - silicone de finition traité antifongique de 5mm de largeur minimum
- ② - silicone d'étanchéité souple traité antifongique
- ③ - élément de soutien du joint silicone
- ④ - silicone d'appui

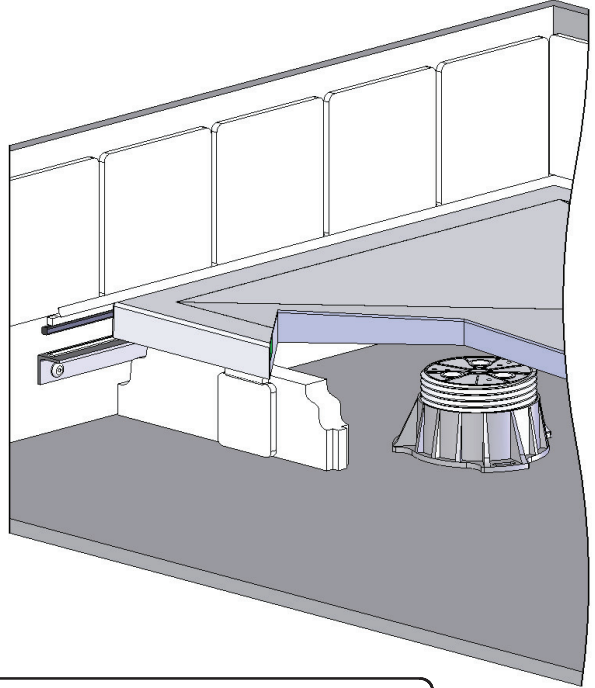
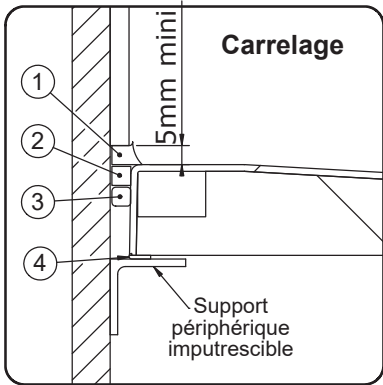

Il est indispensable d'avoir un support imputrescible sur tous les côtés du receveur.

Pose directe au sol ou encastrement bord à bord

Prévoir une zone de bonde plus basse que le sol

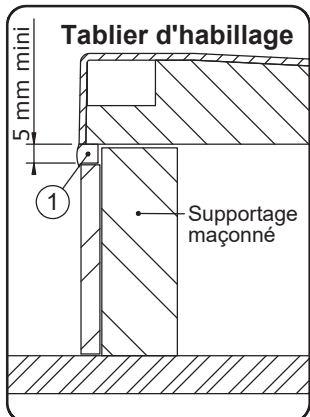
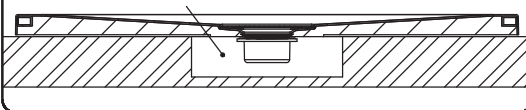

Supportage du fond

Avec pieds fournis en option

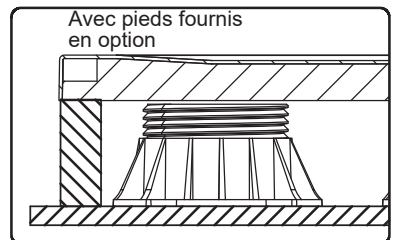



Pendant toute la durée des travaux, protéger le receveur contre toute agression : brûlures, chocs, rayures, décapants...



Le montage d'une *soupape anti-vidé* est nécessaire pour une utilisation optimale si un autre appareil sanitaire est raccordé sur la même évacuation.

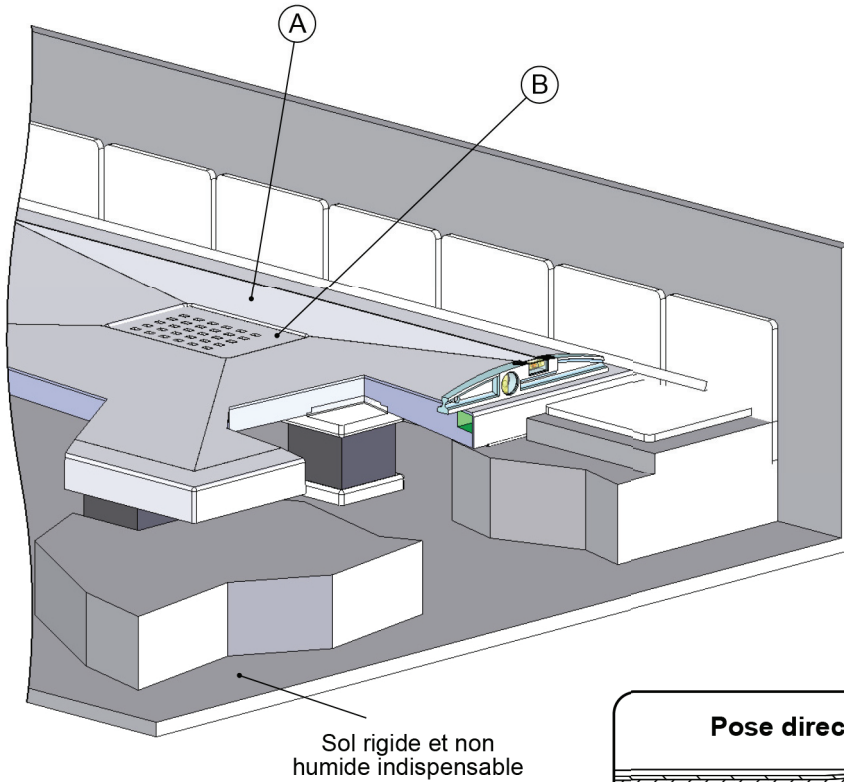

Pose directe au sol

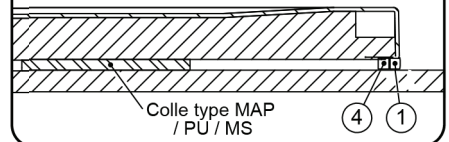

Encastrement bord à bord

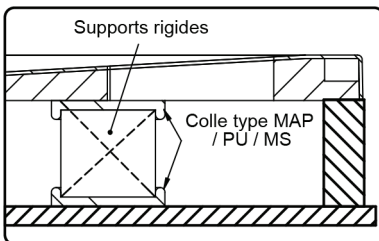
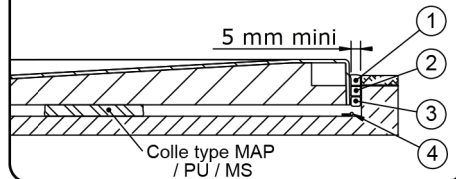

- F MISE EN PLACE DES PLOTS DE COLLE POLYURETHANE OU MS POLYMERE OU MAP
- D BRENG DE POLYURETAAN LIJM OF MS POLYMEERAAN OP DE JUISTE PLAATS OF MAP
- NL LADEN SIE DIE GRUND KLEBER POLYURETHAN ODER MS-POLYMERE ODER MAP

- F Exemple receveur **100x80** ● D Beispiel mit Duschwanne **100 x 80**
- NL voorbeeld met douchebak **100 x 80**

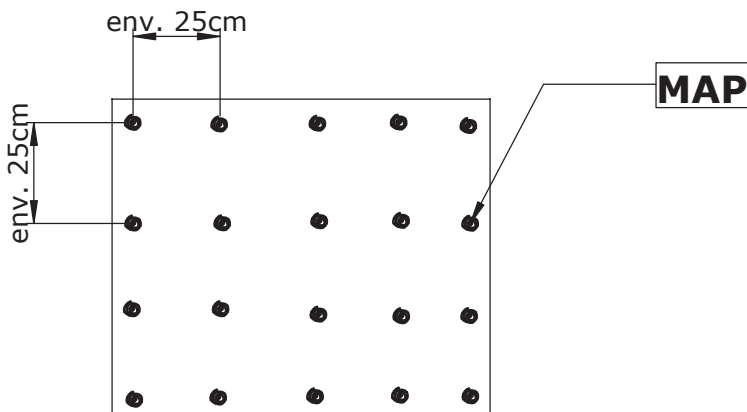
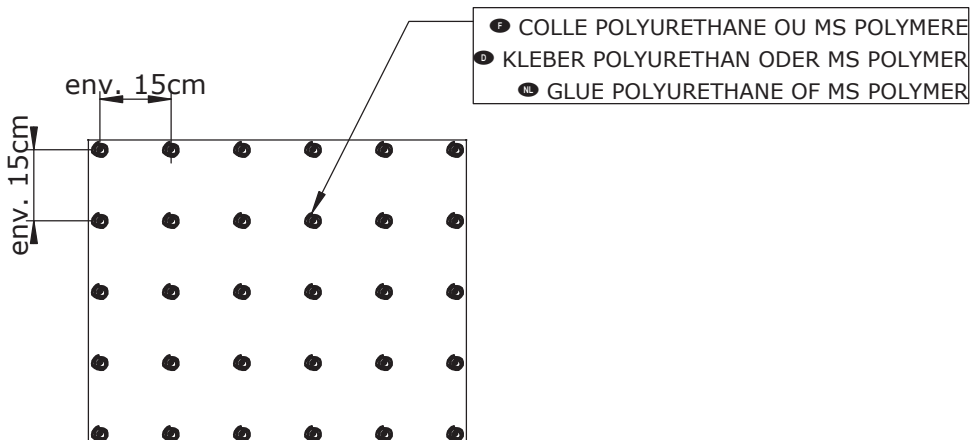

KINESURF TYPE D'INSTALLATIONS POSSIBLES POUR RECEVEUR AVEC BONDE SUR GRAND CÔTÉ ET CARRÉ

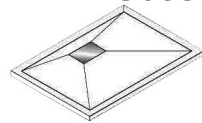

1. Posé sur pieds réglables avec habillage carrelé

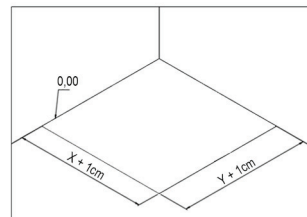
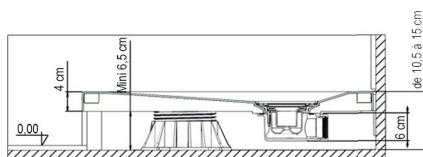
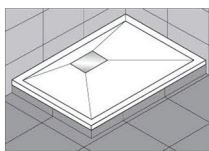

Préparation de l'implantation

2. Posé sur carrelage

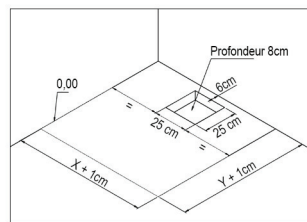
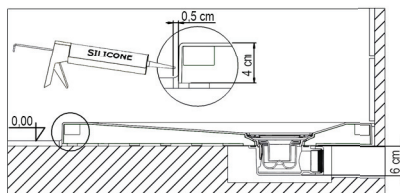
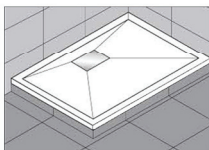

Préparation de l'implantation

3. Encastré et posé sur pieds réglables

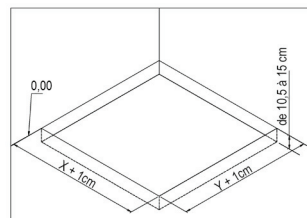
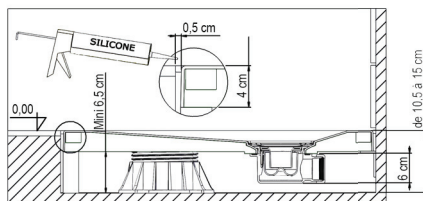
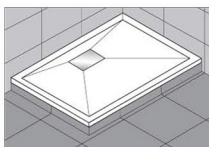

Préparation de l'implantation

4. Encastré et posé sans pieds réglables

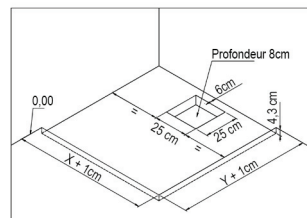
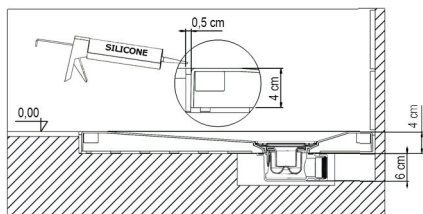
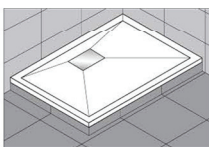

Préparation de l'implantation

KINESURF TYPE D'INSTALLATIONS POSSIBLES POUR RECEVEUR AVEC BONDE SUR PETIT CÔTÉ

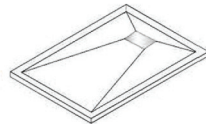

1. Posé sur pieds réglables avec habillage carrelé

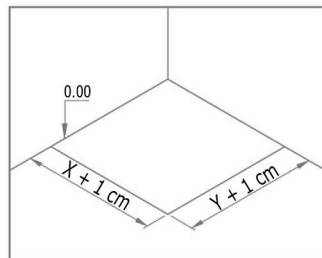
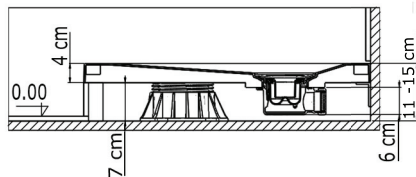
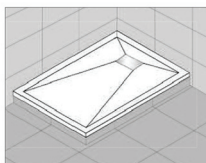

Préparation de l'implantation

2. Posé sur carrelage

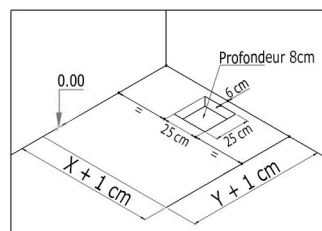
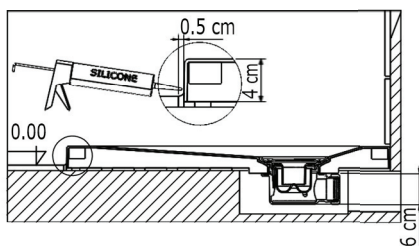
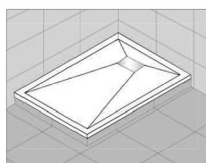

Préparation de l'implantation

3. Encastré et posé sur pieds réglables

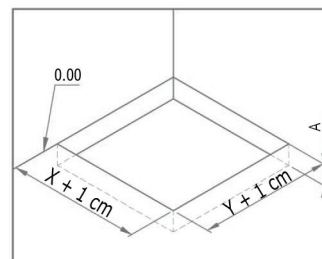
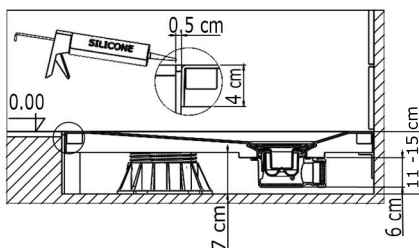
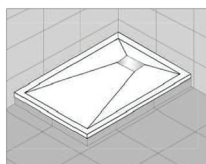

Préparation de l'implantation

4. Encastré et posé sans pieds réglables

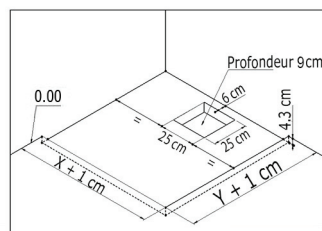
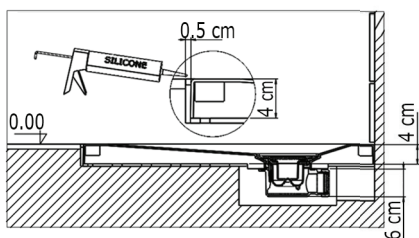
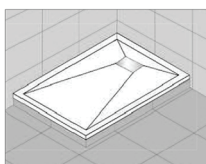

Préparation de l'implantation

KINESURF TYPE D'INSTALLATIONS POSSIBLES POUR RECEVEUR QUART DE ROND

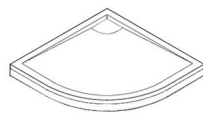

1. Posé sur pieds réglables avec habillage carrelé

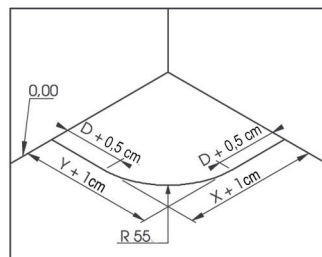
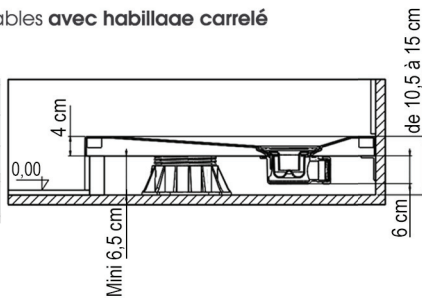
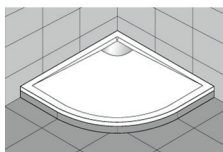

Préparation de l'implantation

2. Posé sur carrelage

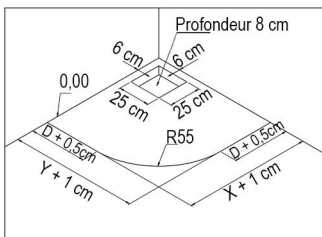
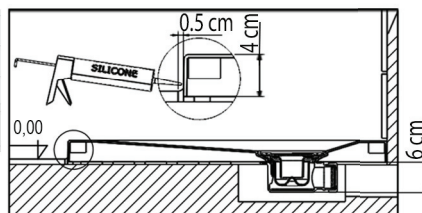
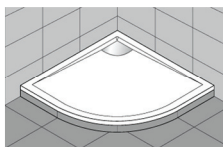

Préparation de l'implantation

3. Encastré et posé sur pieds réglables

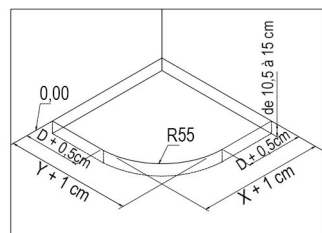
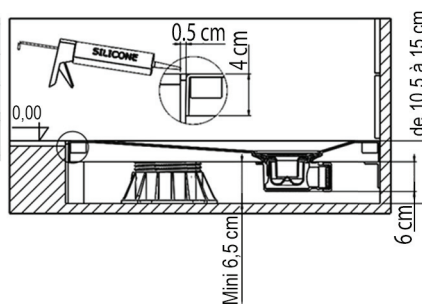
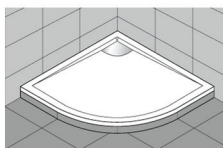

Préparation de l'implantation

4. Encastré et posé sans pieds réglables

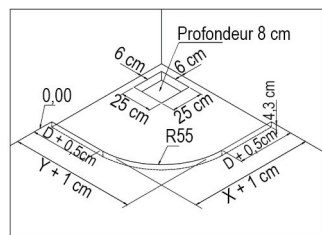
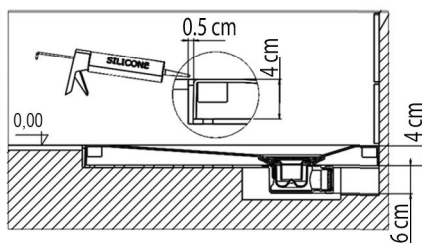
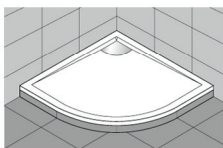

Préparation de l'implantation

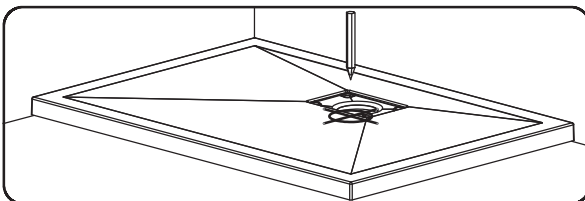

Markeer de positie van de afvoer en bepaal de plaats van de afvoer en de douchebak

Voer geen aanpassingen uit aan de douchebak die niet zijn voorzien door de fabrikant (zagen, slijpen)

- ① - Schimmelwerende siliconenkit met een lengte van minimaal 5mm
- ② - Siliconenkit voor een waterdichte afwerking, met schimmelwerende werking
- ③ - Steunelement van silicone pakking
- ④ - Siliconen ondersteuning

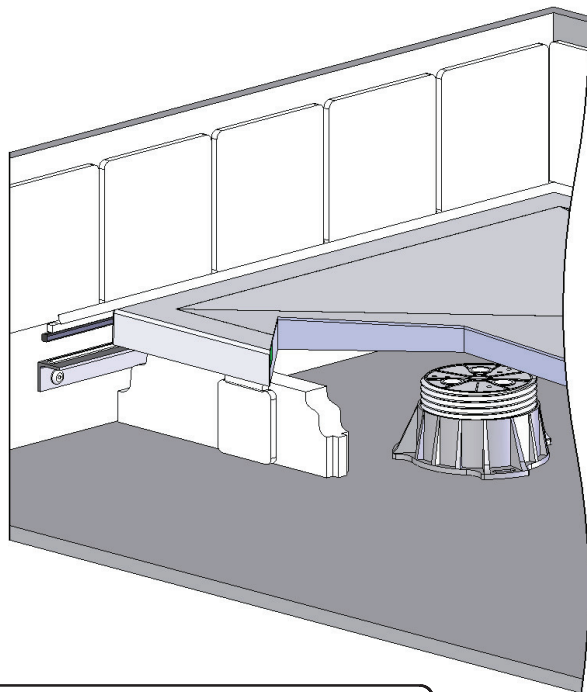
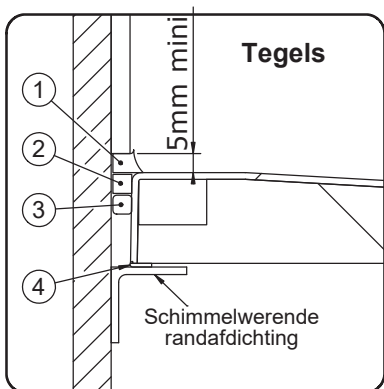

Breng een schimmelwerende afdichting aan, langs alle zijden van de douchebak.

Installatie op de vloer

Voorzie een afvoerhoogte in de vloer

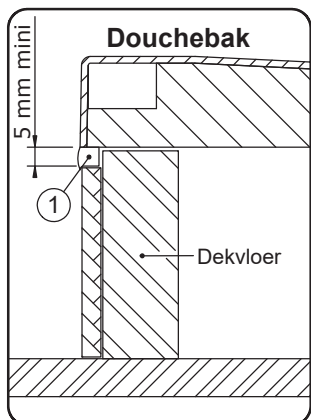
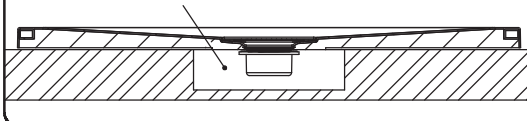

Versterking van de ondergrond

Optioneel geleverd inclusief stelpoten

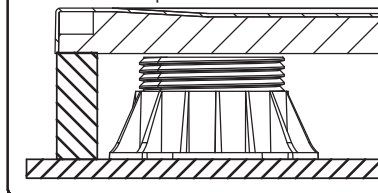



Bescherm de douchebak tijdens de werkzaamheden tegen brand, schokken, krassen etc.



Voor een optimaal gebruik is de montage van een terugslagklep noodzakelijk indien een ander sanitair toestel wordt aangesloten op dezelfde afvoer.

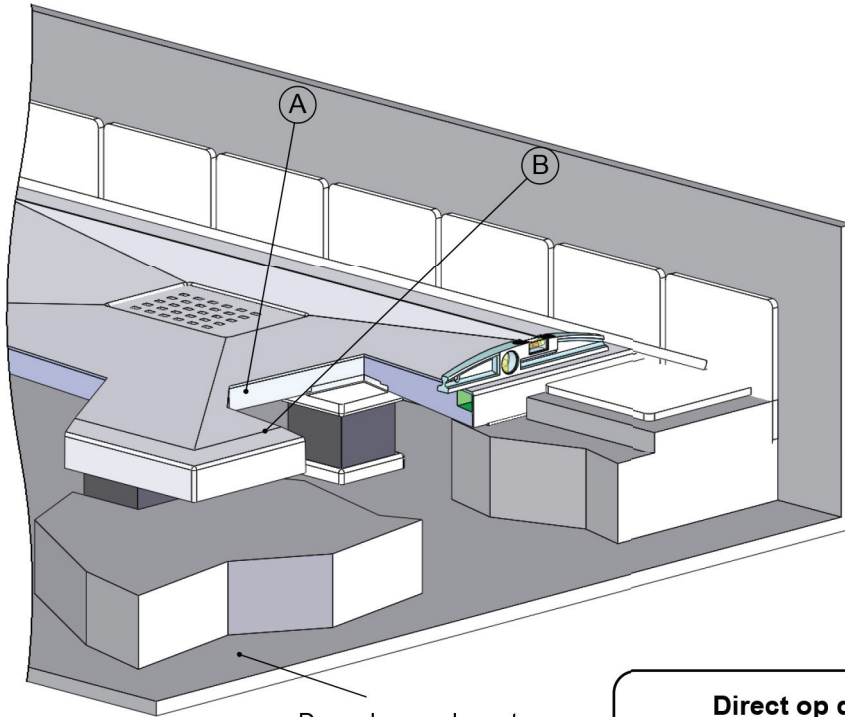

De ondergrond moet volkomen vlak en droog zijn

Direct op de grond

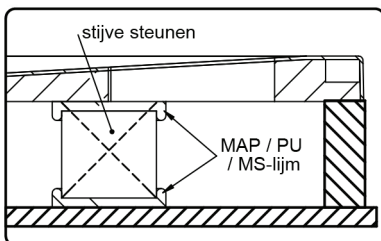
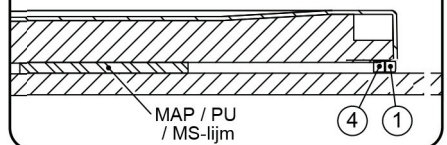

Installatie op de vloer

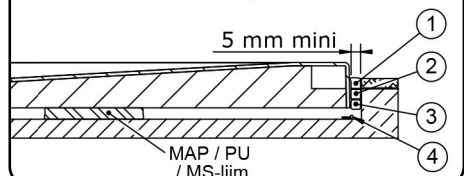

- F MISE EN PLACE DES PLOTS DE COLLE POLYURETHANE OU MS POLYMERE OU MAP
- D BRENG DE POLYURETAAN LIJM OF MS POLYMEERAAN OP DE JUISTE PLAATS OF MAP
- NL LADEN SIE DIE GRUND KLEBER POLYURETHAN ODER MS-POLYMERE ODER MAP

- F Exemple receveur **100x80** ● D Beispiel mit Duschwanne **100 x 80**
- NL voorbeeld met douchebak **100 x 80**

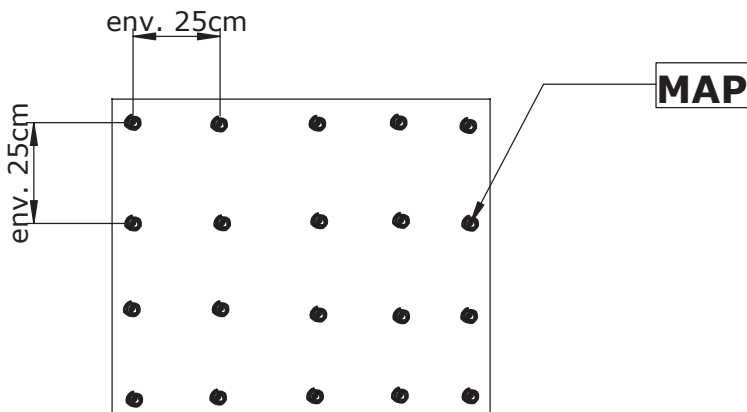
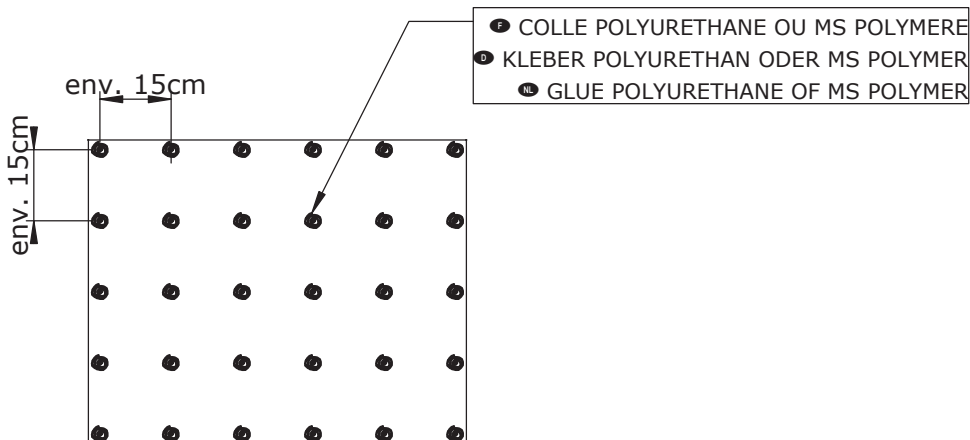

KINESURF

MOGELIJKE INSTALLATIES VOOR DOUCHEBAKKEN MET AFVOERPUTJE AAN DE KORTE ZIJDE EN SQUARE

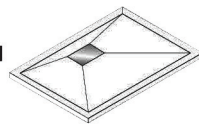

1. Geplaatst op stelpoten en afgewerkt met betegeling

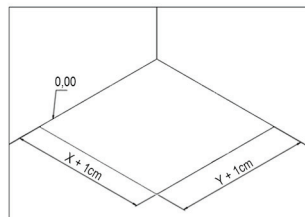
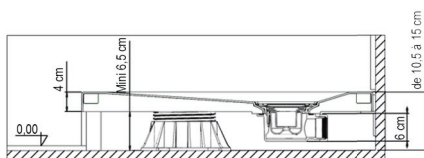
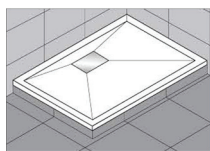

Préparation de l'implantation

2. Geplaatst op tegelvloer

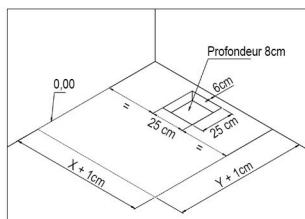
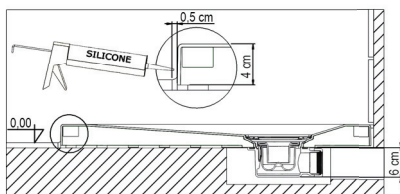
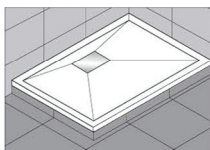

Préparation de l'implantation

3. Ingebouwd en geplaatst op stelpoten

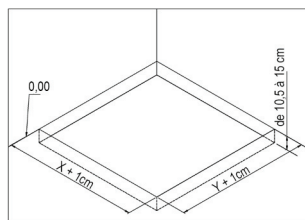
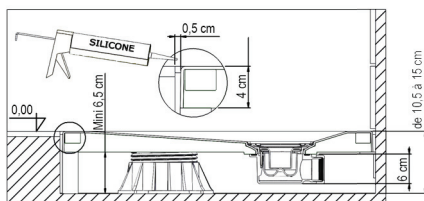
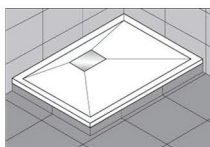

Préparation de l'implantation

4. Ingebouwd en geplaatst zonder stelpoten

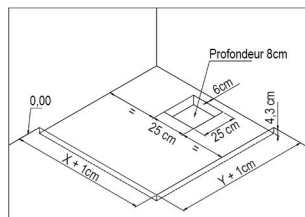
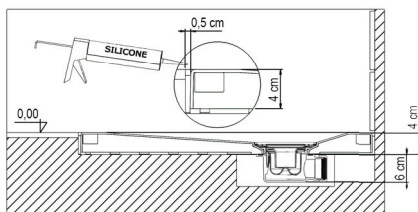
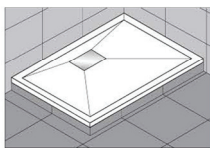

Préparation de l'implantation

KINESURF

MOGELIJKE INSTALLATIES VOOR DOUCHEBAKKEN MET AFVOERPUTJE AAN DE KORTE ZIJDE

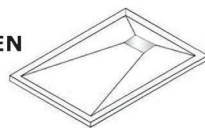

1. Geplaatst op stelpoten en afgewerkt met betegeling

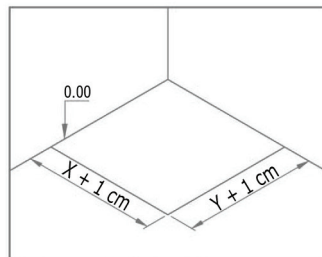
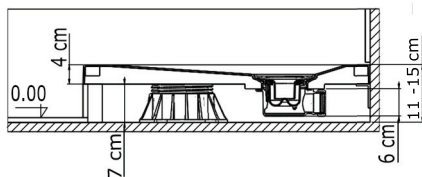
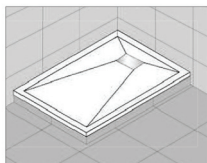

Vorbereitung van de montage

2. Geplaatst op tegelvloer

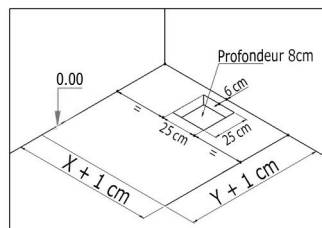
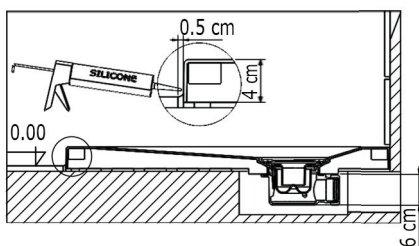
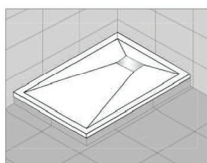

Vorbereitung van de montage

3. Ingebouwd en geplaatst op stelpoten

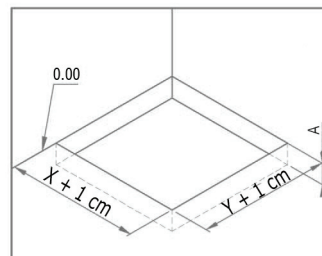
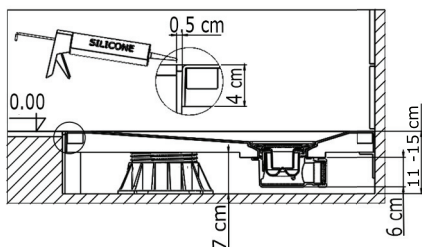
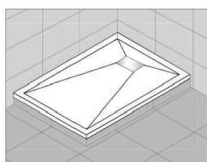

Vorbereitung van de montage

4. Ingebouwd en geplaatst zonder stelpoten

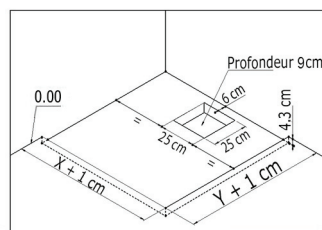
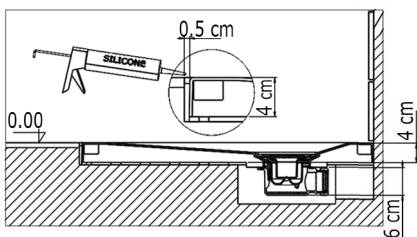
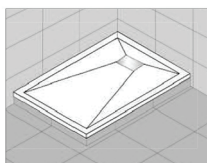

Vorbereitung van de montage

KINESURF

MOGELIJKE INSTALLATIES VOOR DOUCHEBAKKEN KWART ROND

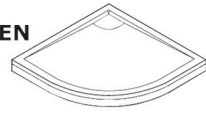

1. Geplaatst op stelpoten en afgewerkt met beteeling

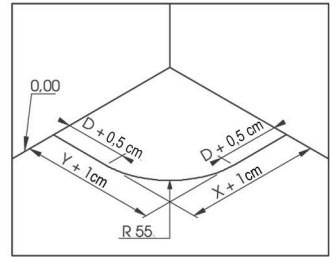
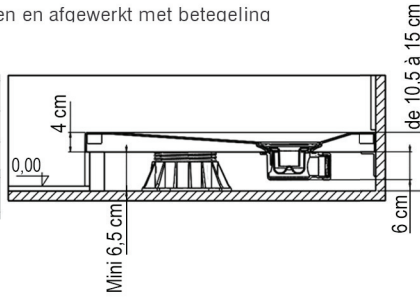
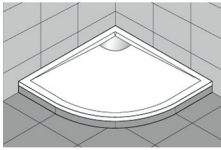

Vorbereitung van de montage
*Voor afmeting D, zie tabel p.2

2. Geplaatst op tegelvloer

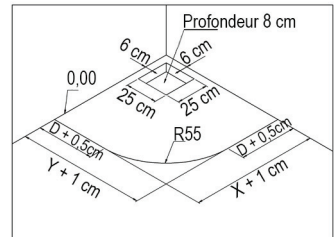
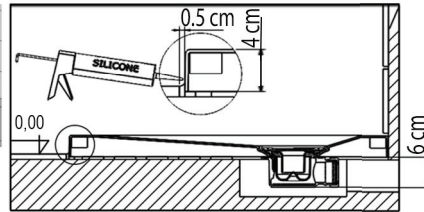
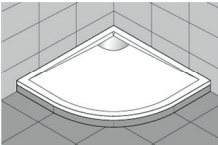

Vorbereitung van de montage
*Voor afmeting D, zie tabel p.2

3. Ingebouwd en geplaatst op stelpoten

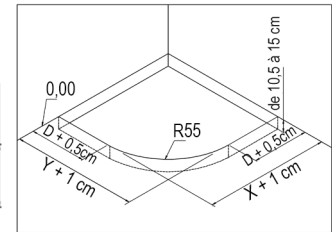
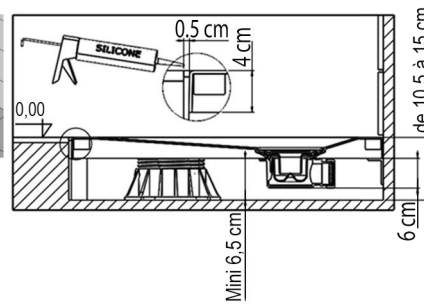
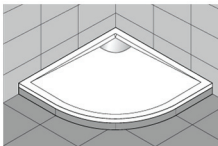

Vorbereitung van de montage
*Voor afmeting D, zie tabel p.2

4. Ingebouwd en geplaatst zonder stelpoten

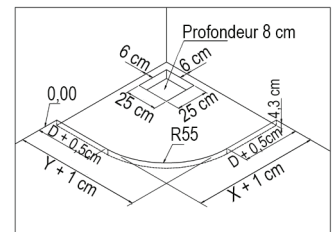
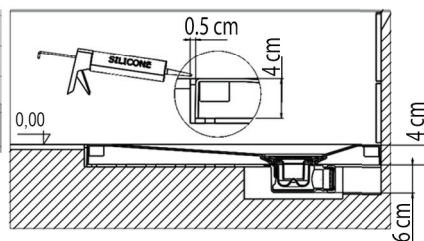
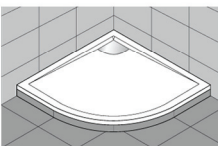

Vorbereitung van de montage
*Voor afmeting D, zie tabel p.2

D

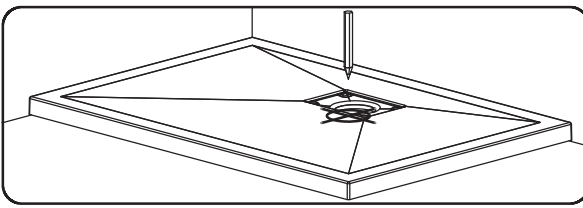

Die Position für den Ablauf anzeichnen und vormontieren



Die Duschtasse darf in keiner anderen als vom Hersteller vorgesehenen Art und Weise verändert werden (durch Sägen, Schleifen etc.)

- ① - Pilzhemmendes Silikon mit einer Mindestbreite von 5mm
- ② - Weiches pilzhemmendes Dichtsilikon
- ③ - Stützelement der Silikondichtung
- ④ - Sanitärsilikon

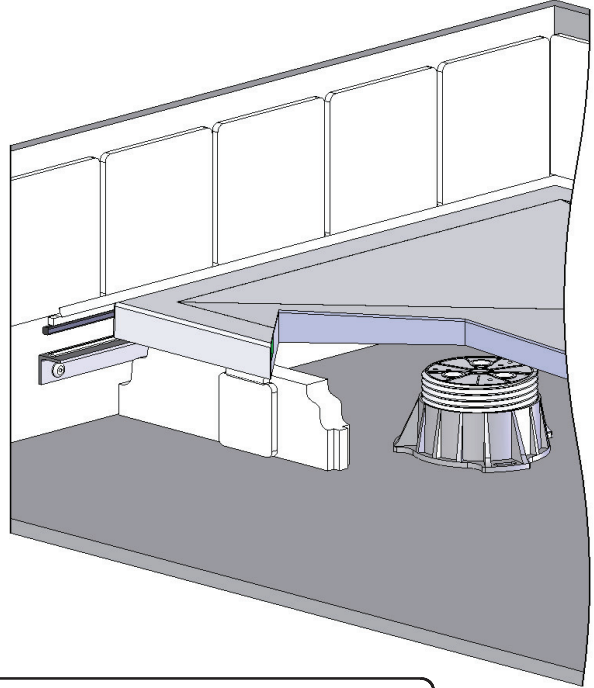
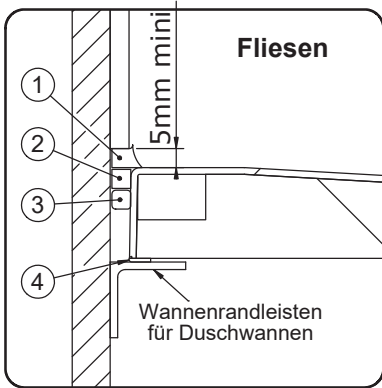

Montage direkt am Boden oder bündige Einbettung

Für den Ablauf eine Aussparung unter dem Boden vorsehen, Mindesttiefe 70mm

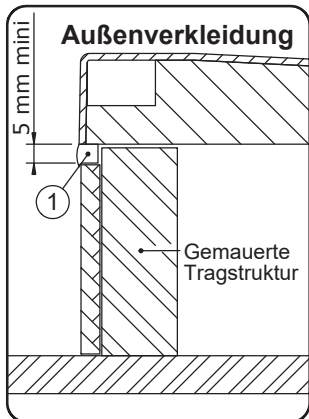
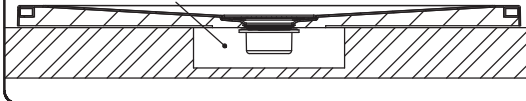

Rückwärtige Tragstruktur

Mit optional gelieferten Sockelfüßen

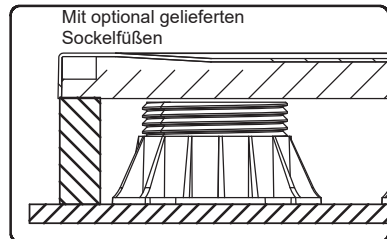

OD



Montage eines Anti-Vakuum-Ventils
ist notwendig für die Verwendung
optimal, wenn ein anderes Sanitärgerät
ist mit der gleichen Evakuierung verbunden.

Während der gesamten Dauer
der Arbeiten ist die Duschtasse
vor allen möglichen
Beschädigungen zu schützen

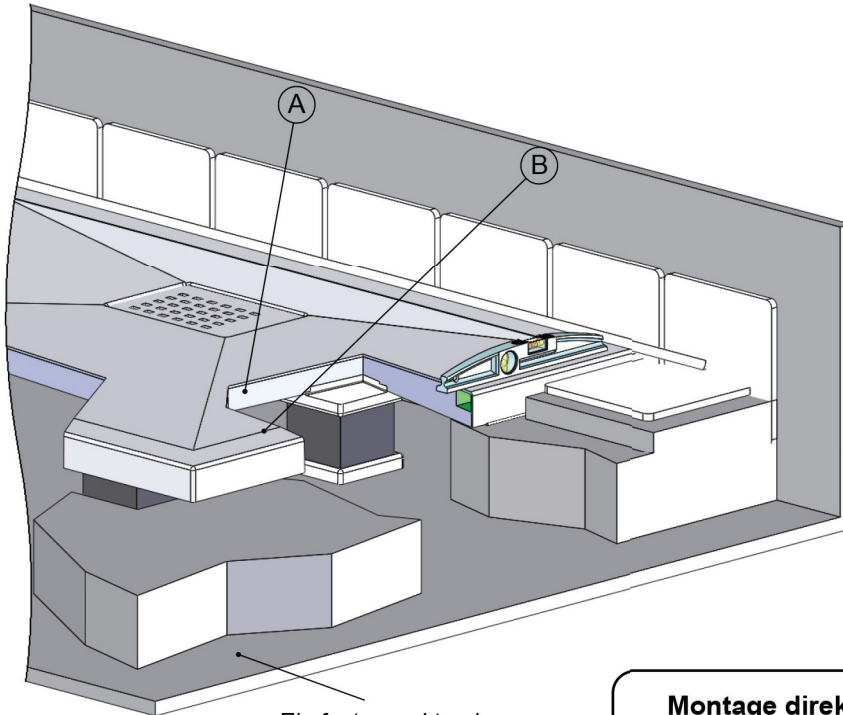

Ein fester und trockener
Untergrund ist unabdingbar

Montage direkt am Boden

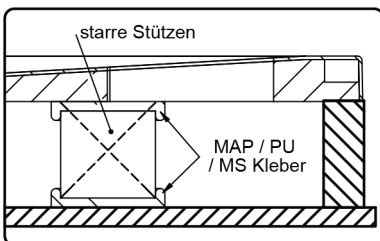
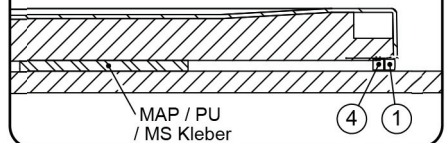

Bündige Einbettung

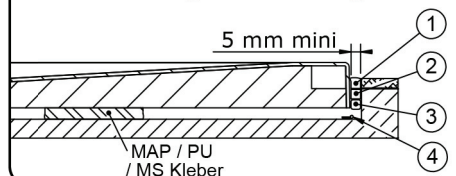

ER

- F MISE EN PLACE DES PLOTS DE COLLE POLYURETHANE OU MS POLYMERE OU MAP
- D BRENG DE POLYURETAAN LIJM OF MS POLYMEERAAN OP DE JUISTE PLAATS OF MAP
- NL LADEN SIE DIE GRUND KLEBER POLYURETHAN ODER MS-POLYMERE ODER MAP

- F Exemple receveur **100x80** ● D Beispiel mit Duschwanne **100 x 80**
- NL voorbeeld met douchebak **100 x 80**

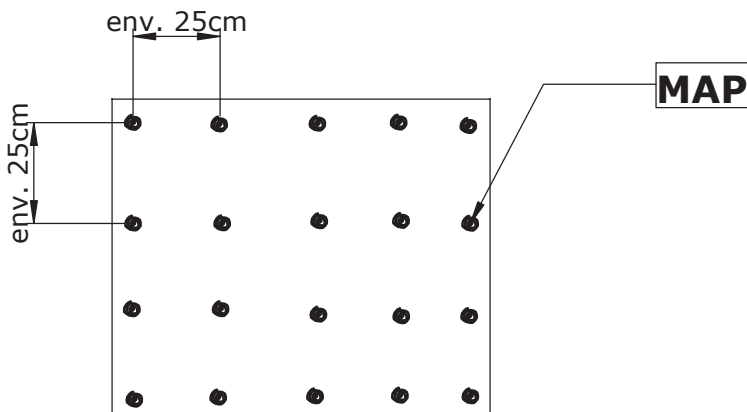
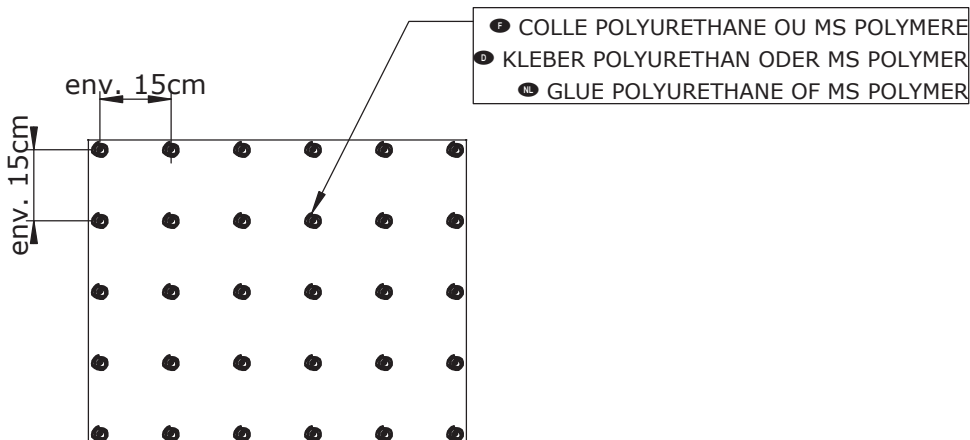

KINESURF MONTAGEMÖGLICHKEITEN FÜR DUSCHTASSEN MIT ABFLAU AN DER LÄNGSSEITE UND QUADRAT

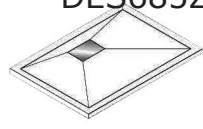

1 Montage auf einstellbarem Fliesensockel

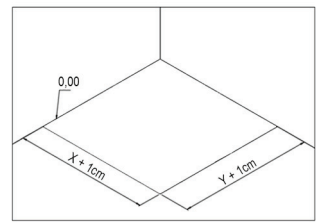
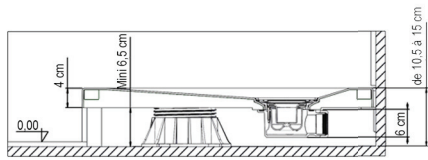
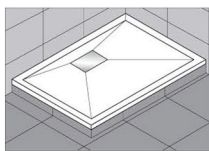

Vorbereitung der Montage

2 Auf Fliesenboden aufliegend

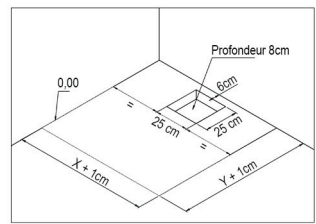
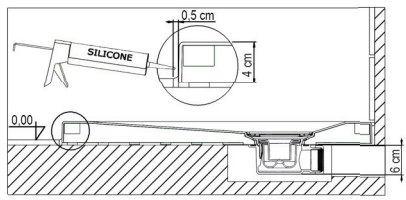
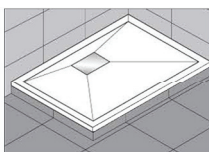

Vorbereitung der Montage

3 Eingebettet und mit einstellbarem Sockel

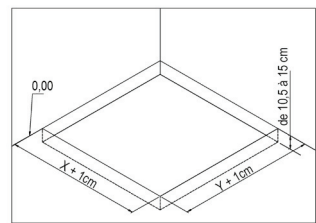
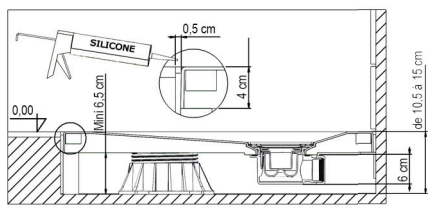
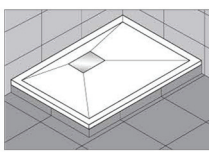

Vorbereitung der Montage

4 Eingebettet und ohne einstellbaren Sockel

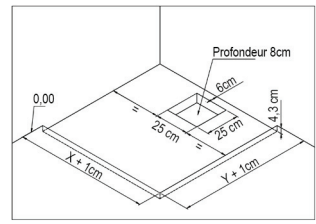
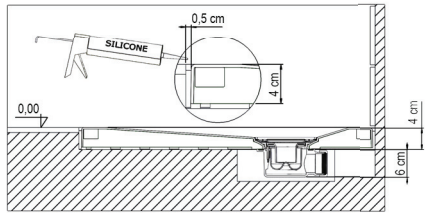
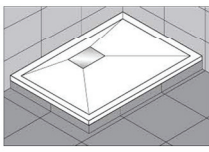

Vorbereitung der Montage

KINESURF MONTAGEMÖGLICHKEITEN FÜR DUSCHWANNEN MIT ABLAUF AN DER QUERSEITE

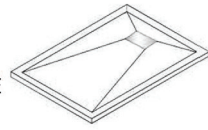

1. Montage auf einstellbarem Fliesensockel

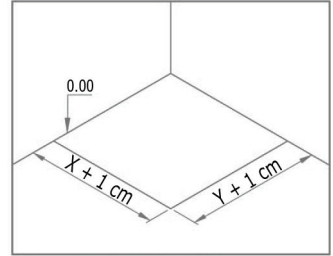
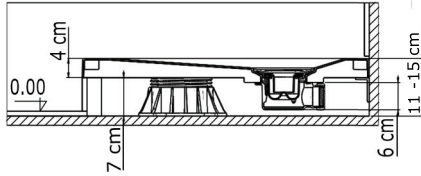
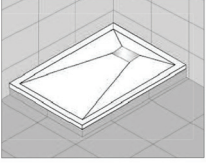

Vorbereitung der Montage

2. Auf Fliesenboden aufliegend

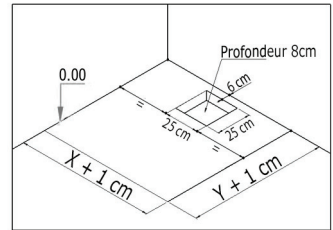
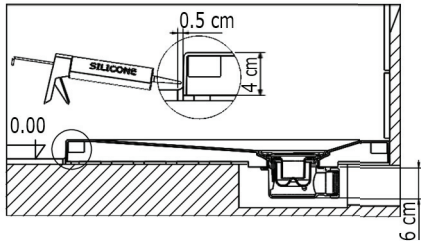
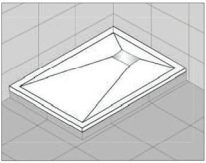

Vorbereitung der Montage

3. Eingebettet und mit einstellbarem Sockel

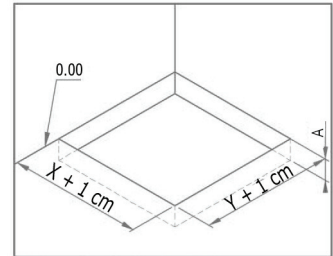
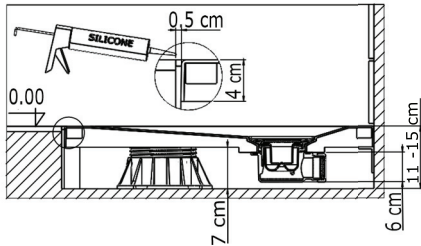
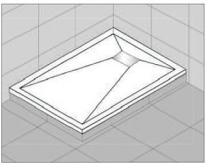

Vorbereitung der Montage

4. Eingebettet und ohne einstellbaren Sockel

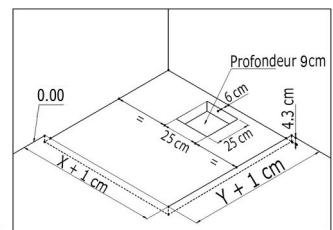
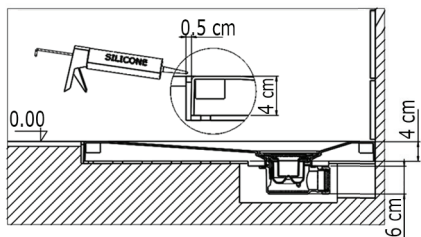
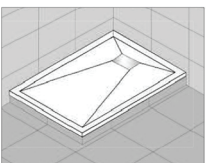

Vorbereitung der Montage

KINESURF MONTAGEMÖGLICHKEITEN FÜR FÜR QUARTER ROUND DUSCHE



1) Montage auf einstellbarem Fliesensockel

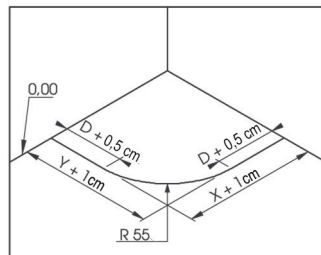
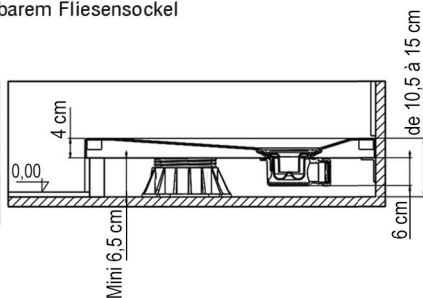
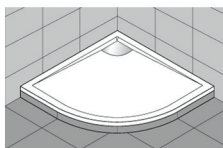

Vorbereitung der Montage

*Maß D bitte in Tabelle auf S.2 nachlesen

2. Auf Fliesenboden aufliegend

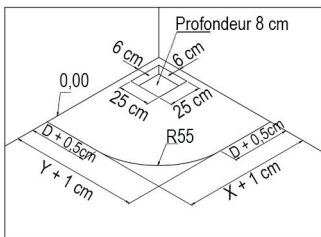
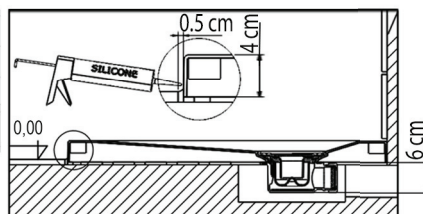
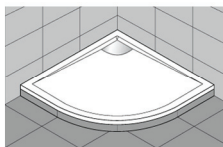

Vorbereitung der Montage

*Maß D bitte in Tabelle auf S.2 nachlesen

3. Eingebettet und mit einstellbarem Sockel

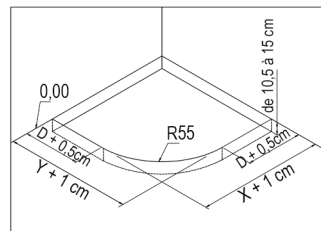
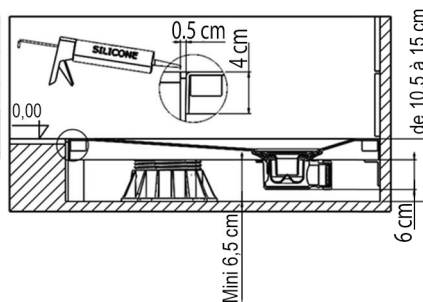
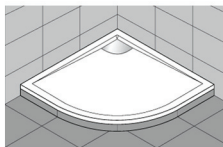

Vorbereitung der Montage

*Maß D bitte in Tabelle auf S.2 nachlesen

4. Eingebettet und ohne einstellbaren Sockel

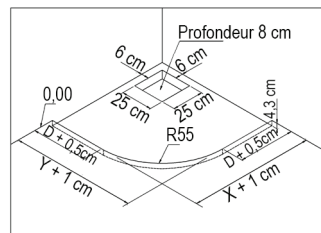
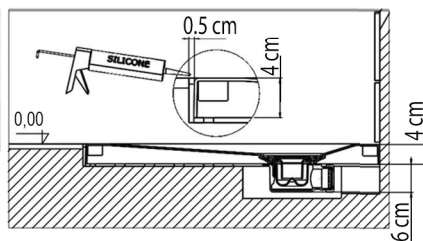
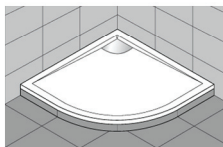

Vorbereitung der Montage

*Maß D bitte in Tabelle auf S.2 nachlesen



SAV
SERVICE HELPLINES
ASSISTENZA POST-VENTITA
SERVICIO POSTVENTA

FRANCE

02 40 21 29 45

UK

020 8842 0033

IRELAND

04697 33102

DEUTSCHLAND

+49 (0) 6074 / 30928 0

ITALIA

(0382) 6181

OSTEREICH

+43 1 710 60 70

SCHWEIZ

(01) 748 17 44

ESPANA

93 544 60 76

NEDERLAND

+31 475 487 100

BELGIE

+31 475 487 100

BELGIQUE

+31 475 487 100

РОССИЯ

963 19 40, 773 67 22



AQUAPRODUCTION, Site industriel,
 F - 44680 Chaumes-en-Retz

09

EN 14527 - CL2

Aptitude au nettoyage : satisfaisant
 Durabilité : satisfaisant