

Notice de pose

## Collection INFINI

-

Meuble 3 tiroirs - largeur 80/90/100/120



**Concilio**  
BATHROOM DESIGN

# 1/ Schéma de pose

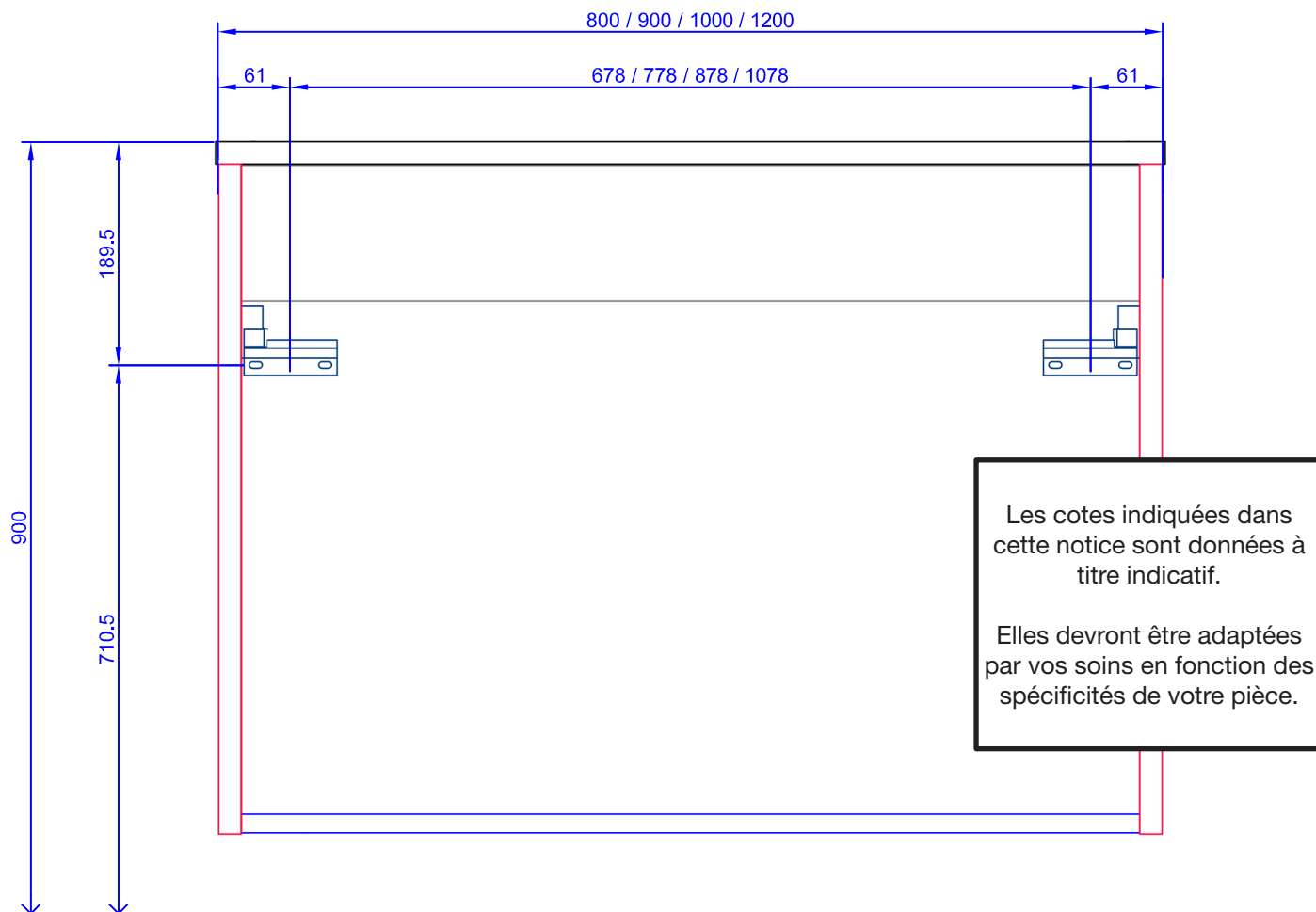

Attaches murales :

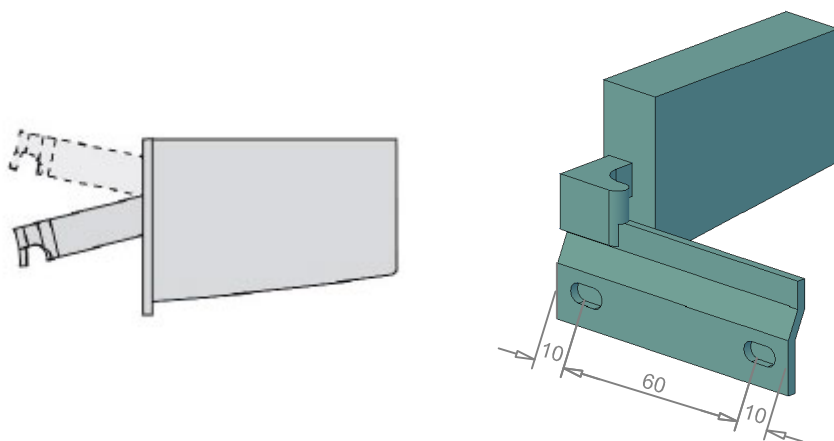

## 2/ Démontage des tiroirs

Tiroir à ouvrir entièrement.

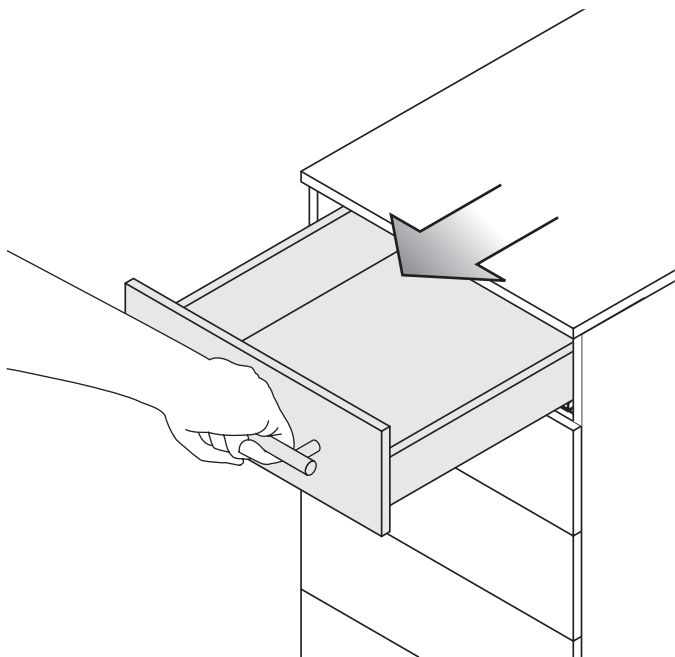

Fermez alors 10 cm.

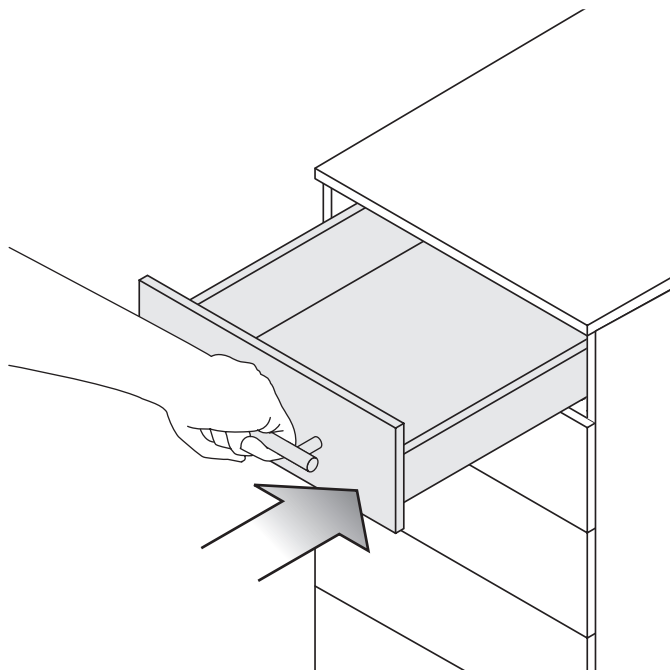

Soulevez légèrement et tirez avec élan.

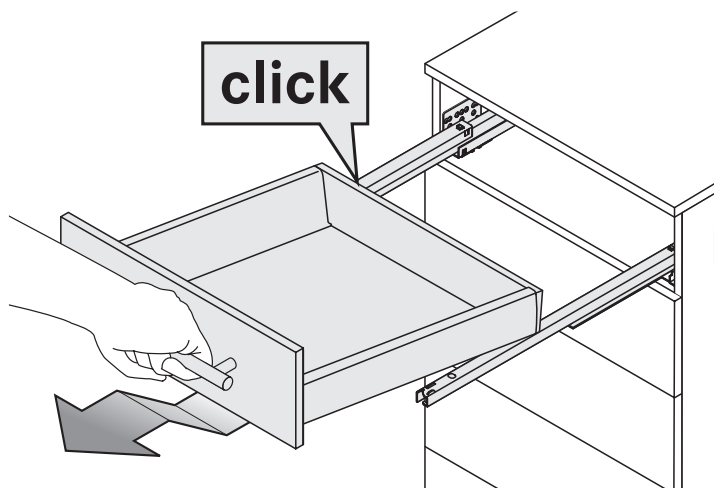

## 3/ Montage des tiroirs

Posez le tiroir sur la partie coulissante extraite.

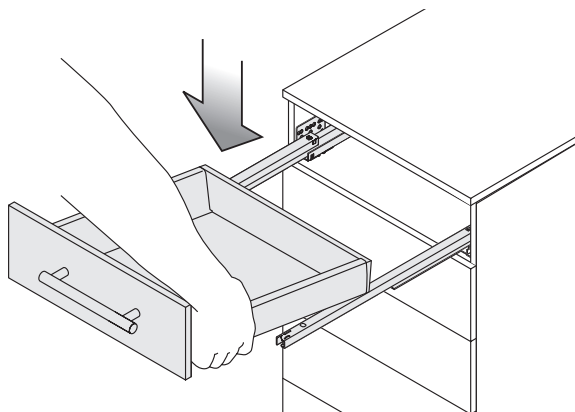

Fermez complètement le tiroir – il se positionne automatiquement.

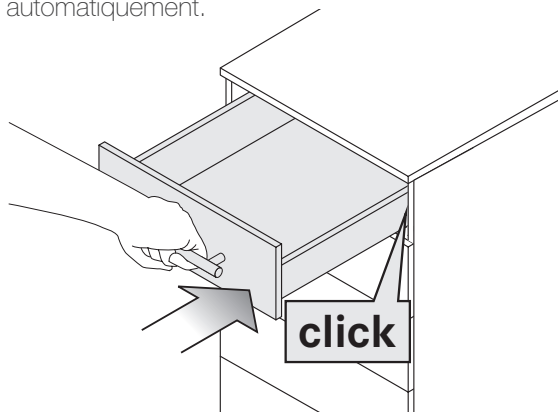

## 4/ Réglage des tiroirs

Montage de façade

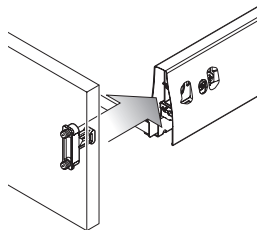

Démontage de façade

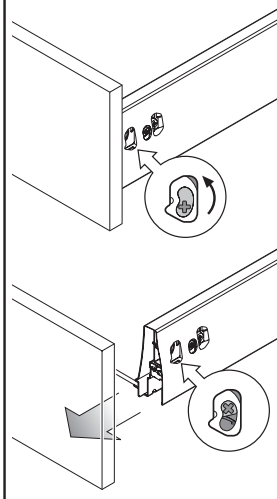

Réglage latéral

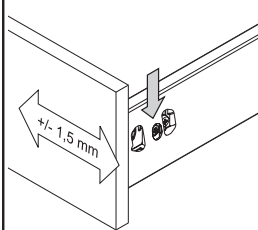

Réglage hauteur

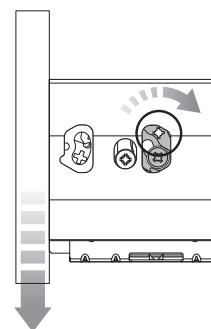
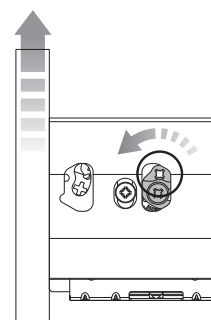
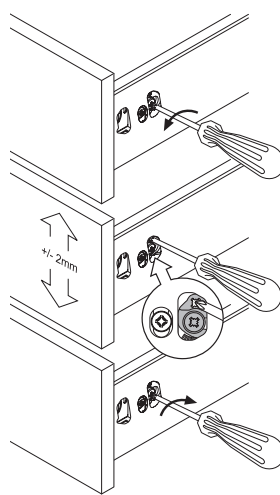

Réglage en inclinaison

